

# DASA

LIGHT YOUR LIFE

## VITTORIA XS-2000

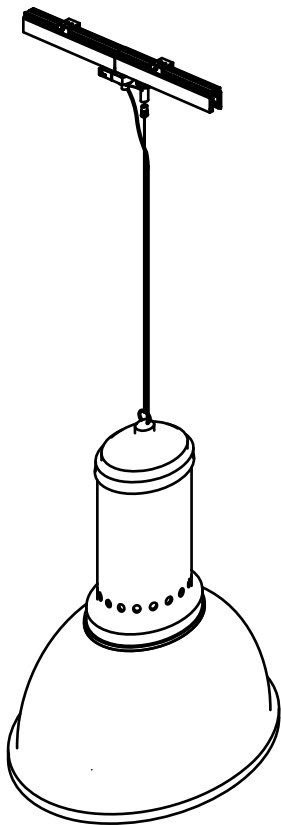

- A: XTT TESTATA DI GIUNTURA  
JOINT HEAD
- A1: XTS SUPPLY
- B: FISCHER
- B1: VITI SCREWS
- C: SFS STAFFA FISSAGGIO  
SOFFITTO  
CEILING MOUNTING  
BRACKET
- D: SFLB STAFFA FISSAGGIO  
LAMPADA SOFFITTO  
CEILING MOUNTING  
LAMP BRACKET
- E: XTSA

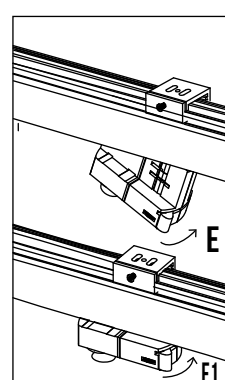
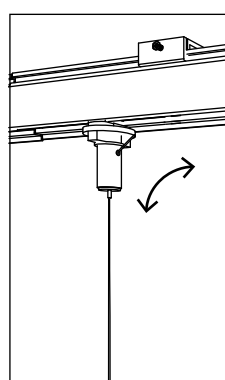
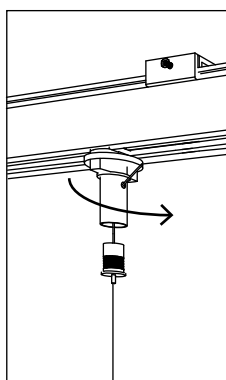
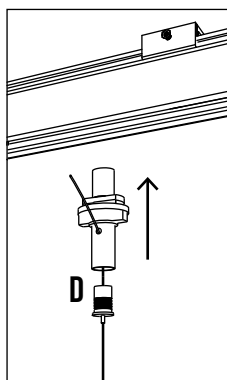
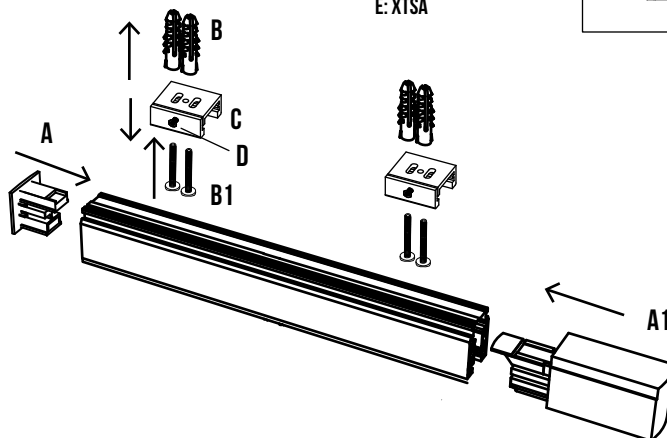
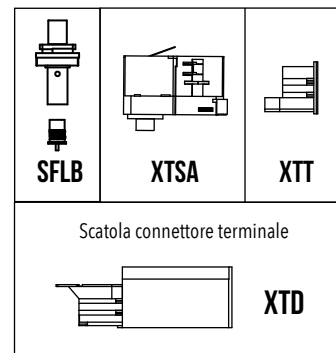

- PASSO1** : fissare la staffa (C) alla parete tramite le viti in dotazione (B1). Assicurarsi di aver precedentemente inserito i fischer da 6 mm (B) alla parete.
- PASSO2** : inserire la testata di giuntura XTT (A) e l'XTS (A1) alle due estremità del binario.
- PASSO3** : fissare il binario alla staffa tramite la vite (D)
- PASSO4** : inserire la staffa (D) nel binario e fissarla applicando una rotazione di 90°. E' possibile regolare l' altezza del cavo di sospensione .
- PASSO5** : inserire l'XTSA (E) nel binario e ruotare l'adattatore(E1).

- STEP1**: secure the bracket (C) to the wall using the supplied screws (B1). Make sure you have previously entered the fischer from 6 mm (B) to the wall.
- STEP2** : insert the XTT joint head(A) and XTS(A1) to the two ends of the track
- STEP3** : secure the track(D)to the bracket using the screw
- STEP4** : insert the bracket in the track and secure it by applying a rotation of 90°. It's possible to adjust the height of the suspension cable.
- STEP5** : insert the XTSA (E)in the track and rotate the adapter (E1)

### SEDE OPERATIVA

Via della cereria 11, 00071 Pomezia (Roma) - Italy  
tel. (+39) 06.91626677 officinedasa@officinedasa.it